

**MOSAIC**  
*Collection*

# POOL Collection

สีของน้ำช่วยสร้างบรรยากาศให้สวยงามสมจริงและดึงดูดเด่นของสระขึ้นมาทำให้รู้สึกได้เหมือนคลายเสมือนอยู่ท่ามกลางชายหาด และทะเลธรรมชาติ COTTO จึงนำเสนอในรูปแบบสีของน้ำที่หลากหลาย โดยแบ่งเป็นโทนสีอ่อน Baby Blue, Light Blue, Sky Blue ไปจนถึงโทนสีเข้ม Turquoise, Pacific Blue, Midnight Blue ตอบโจทย์ทุกสไตล์ได้อย่างลงตัว



**BABY BLUE**



**LIGHT BLUE**



**SKY BLUE**

Sea color styles create the aesthetic and unique pool for relaxing like a beach and ocean vibes, COTTO presents type of water color from light tone (Baby Blue, Light Blue, Sky Blue) to dark tone (Turquoise, Pacific Blue, Midnight Blue) applicable for every style.



**TURQUOISE**



**PACIFIC BLUE**



**MIDNIGHT BLUE**





# 4SR1

## GLAZED MOSAIC TILE

(Tile Size 97.0x97.0 mm.)  
(Sheet Size 297.0x297.0 mm.)



4SR1-CALACATTA  
4SR1-CARCARIANA



4SR1-S MARBLE  
4SR1-SILVER MARBLE



4SR1-HIDEAWAY ALPINE LT-GY  
4SR1-HAMMOND LT-GREY

# 2SR1

## GLAZED MOSAIC TILE

(Tile Size 47.0x47.0 mm.)  
(Sheet Size 297.0x297.0 mm.)



2SR1-HIDEAWAY ALPINE  
LIGHT GREY

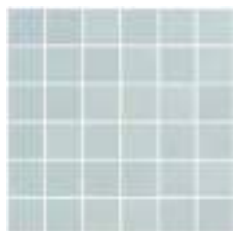

2SR1-CELADON MINT

# 2SM

## GLAZED MOSAIC TILE

(Tile Size 48.0x48.0 mm.)  
(Sheet Size 298.0x298.0 mm.)



2SM-HAMMOND LIGHT GREY



# 4SR1

## GLAZED MOSAIC TILE

(Tile Size 97.0x97.0 mm.)  
(Sheet Size 297.0x297.0 mm.)



4SR1-HIDEAWAY ALPINE GREY  
4SR1-HAMMOND GREY



4SR1-GRAIN GREY



4SR1-MIX STONE GREY

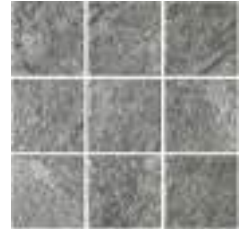

4SR1-MOTTO GREY

# 2SR1

## GLAZED MOSAIC TILE

(Tile Size 47.0x47.0 mm.)  
(Sheet Size 297.0x297.0 mm.)

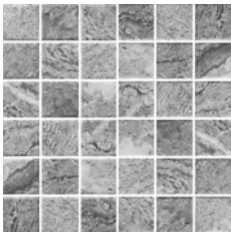

2SR1-HIDEAWAY ALPINE GREY

# 2SM

## GLAZED MOSAIC TILE

(Tile Size 48.0x48.0 mm.)  
(Sheet Size 298.0x298.0 mm.)



2SM-HAMMOND GREY



2SM-MOTTO GREY





# 4SR1

## GLAZED MOSAIC TILE

(Tile Size 97.0x97.0 mm.)  
(Sheet Size 297.0x297.0 mm.)



4SR1-6423



4SR1-RESORT SKY BLUE (SW)

# 2SR1

## GLAZED MOSAIC TILE

(Tile Size 47.0x47.0 mm.)  
(Sheet Size 297.0x297.0 mm.)

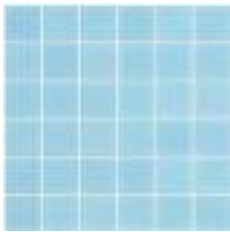

2SR1-CELADON AQUA

# 2SM

## GLAZED MOSAIC TILE

(Tile Size 48.0x48.0 mm.)  
(Sheet Size 298.0x298.0 mm.)

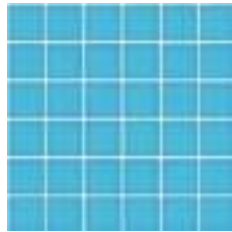

2SM-5496

# 22S

## GLAZED MOSAIC TILE

(Tile Size 57.8x57.8 mm.)  
(Sheet Size 304.0x304.0 mm.)

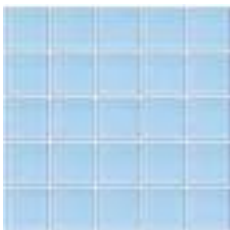

22S-BL-4/R

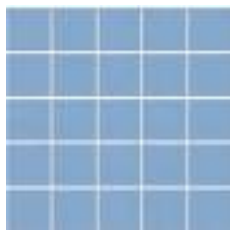

22S-6423



22S CARRERA SKY



# 4SR1

## GLAZED MOSAIC TILE

(Tile Size 97.0x97.0 mm.)  
(Sheet Size 297.0x297.0 mm.)



4SR1-HIDEAWAY ALPINE GREEN  
4SR1-HAMMOND GREEN

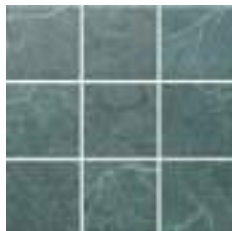

4SR1-I GREEN

# 2SR1

## GLAZED MOSAIC TILE

(Tile Size 47.0x47.0 mm.)  
(Sheet Size 297.0x297.0 mm.)



2SR1-CELADON EMERALD

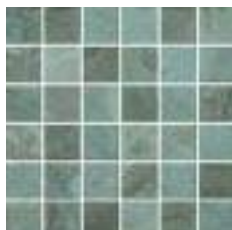

2SR1-HIDEAWAY ALPINE GREEN

# 2SM

## GLAZED MOSAIC TILE

(Tile Size 48.0x48.0 mm.)  
(Sheet Size 298.0x298.0 mm.)

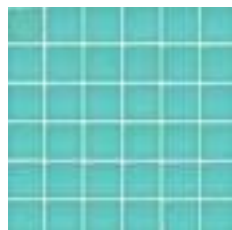

2SM-5376



2SM-HAMMOND GREEN

# 22S

## GLAZED MOSAIC TILE

(Tile Size 57.8x57.8 mm.)  
(Sheet Size 304.0x304.0 mm.)



22S-BL-3/R



22S CARRERA GREEN



22S RESORT PALM GREEN



22S-BL-13/R

# POOL Collection



# 4SR1

## GLAZED MOSAIC TILE

(Tile Size 97.0x97.0 mm.)  
(Sheet Size 297.0x297.0 mm.)

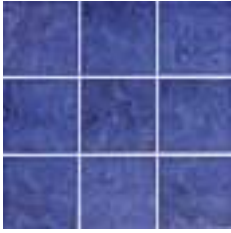

4SR1-RESORT MARINE BLUE (SW)



4SR1-RESORT BEACH BLUE(SW)

# 2SR1

## GLAZED MOSAIC TILE

(Tile Size 47.0x47.0 mm.)  
(Sheet Size 297.0x297.0 mm.)

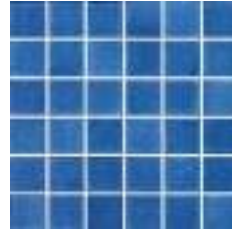

2SR1-CELADON COBALT



2SR1-CELADON AZURE

# 22S

## GLAZED MOSAIC TILE

(Tile Size 57.8x57.8 mm.)  
(Sheet Size 304.0x304.0 mm.)



22S RESORT MARINE BLUE

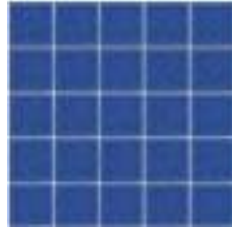

22S-BL-6/R



22S-BL-9/ITL



22S RESORT BEACH BLUE



22S-BL-9/R

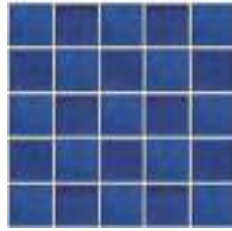

22S-BL-10/R

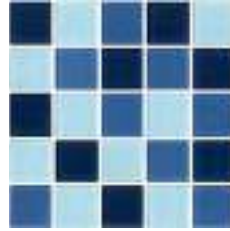

22S-MBL-14/R

# 2SM

## GLAZED MOSAIC TILE

(Tile Size 48.0x48.0 mm.)  
(Sheet Size 298.0x298.0 mm.)

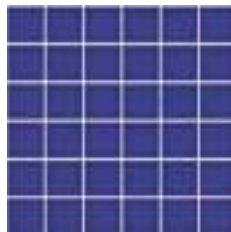

2SM-5494

# 1S

## GLAZED MOSAIC TILE

(Tile Size 25.0x25.0 mm.)  
(Sheet Size 300x327.5 mm.)

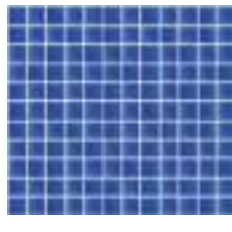

1S-BL-9/R



# 4SR1

## GLAZED MOSAIC TILE

(Tile Size 97.0x97.0 mm.)  
(Sheet Size 297.0x297.0 mm.)



4SR1-GRAIN COAL



4SR1-MOTTO COAL



4SR1-BL-15/R (SW)

# 2SR1

## GLAZED MOSAIC TILE

(Tile Size 47.0x47.0 mm.)  
(Sheet Size 297.0x297.0 mm.)

# 2SM

## GLAZED MOSAIC TILE

(Tile Size 48.0x48.0 mm.)  
(Sheet Size 298.0x298.0 mm.)

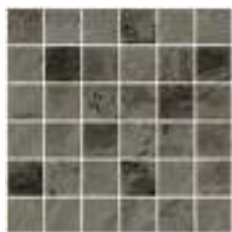

2SR1-ARCHI STONE 1.1



2SM-MOTTO COAL

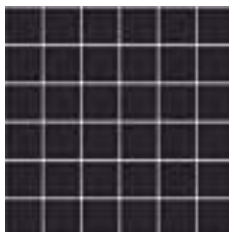

2SM-5790

# 22S

## GLAZED MOSAIC TILE

(Tile Size 57.8x57.8 mm.)  
(Sheet Size 304.0x304.0 mm.)



22S AQUA TEAL BLUE

# POOL Accessories

## ขั้นบันได Step thread tiles

MT 4SL-ST-5 MARBLE (SW) PM  
MT 4SL-ST-CALACATTA (SW) PM  
MT 4SL-ST-HIDEAWAY ALPINE GREEN PM  
MT 4SL-ST-HIDEAWAY ALPINE LT-GY PM  
MT 4SL-ST-HIDEAWAY ALPINE GREY PM

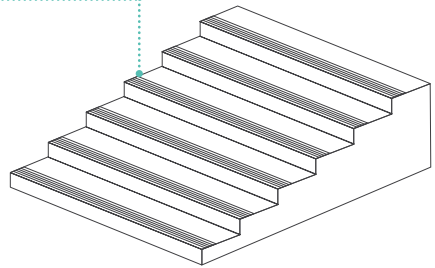

## ขอบมันนอก External Corner

MT 4SL-EX-CALACATTA PM  
MT 4SL-EX-HIDEAWAY ALPINE GREEN PM  
MT 4SL-EX-HIDEAWAY ALPINE LT-GY PM  
MT 4SL-EX-HIDEAWAY ALPINE GREY PM  
MT 4SL-EX-S MARBLE (SW) PM

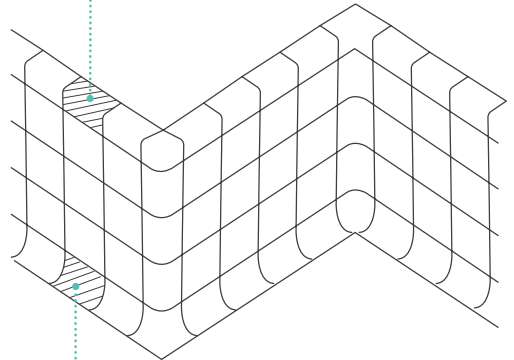

## ขอบมันใน Internal Corner

MT 4SL-IN-CALACATTA (SW) PM  
MT 4SL-IN-HIDEAWAY ALPINE GREEN PM  
MT 4SL-IN-HIDEAWAY ALPINE LT-GY PM  
MT 4SL-IN-HIDEAWAY ALPINE GREY PM  
MT 4SL-IN-S MARBLE (SW) PM









**DECORATIVE**  
Mosaic & Glass

▪ **MOSAIC** ▪  
COLLECTION



# 4SR1

## GLAZED MOSAIC TILE

(Tile Size 97.0x97.0 mm.)  
(Sheet Size 297.0x297.0 mm.)

SURFACE : GLOSSY



4SR1-6110



4SR1 CLASSICO



4SR1-PRONTO COOL



4SR1-PRONTO WARM

SURFACE : MATT



4SR1-PICO AZUL



4SR1-PICO BIANCO



4SR1-PICO GRIGIO



4SR1 PORTO

SURFACE : SATIN

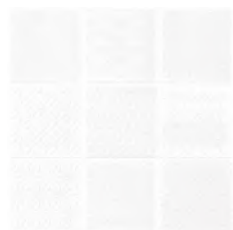

4SR1 SPIRIT WHITE



4SR1 SPIRIT COPPER

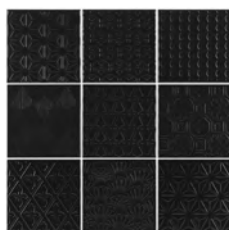

4SR1 SPIRIT BLACK

# 4SR1 GI

UNGLAZED PORCELAIN

(Tile Size 97.0x97.0 mm.)  
(Sheet Size 297.0x297.0 mm.)

SURFACE : MATT



4SR1-GI-7000



4SR1-GI-7002

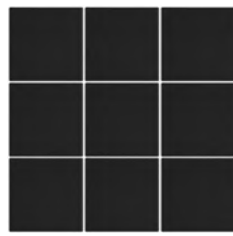

4SR1-GI-7003

# 06T GI

UNGLAZED PORCELAIN

(Tile Size 21.9x72.8 mm.)  
(Sheet Size 290.0x299.0 mm.)

SURFACE : MATT

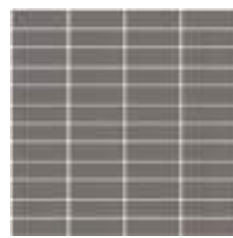

06T-GI-7002N

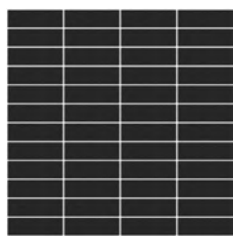

06T-GI-7003N

# 2SR1 GI

UNGLAZED PORCELAIN

(Tile Size 47.0x47.0 mm.)  
(Sheet Size 297.0x297.0 mm.)

SURFACE : MATT



2SR1-GI-7003

# 22S

GLAZED MOSAIC TILE

(Tile Size 57.8x57.8 mm.)  
(Sheet Size 304.0x304.0 mm.)

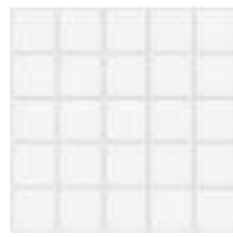

22S-6110

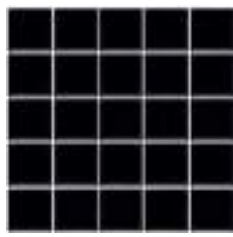

22S-6790





# 1S

## GLAZED MOSAIC TILE

(Tile Size 25.0x25.0 mm.)  
(Sheet Size 300x327.5 mm.)

SURFACE : ANTI-SLIP

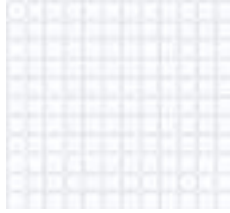

1S-AS-0111

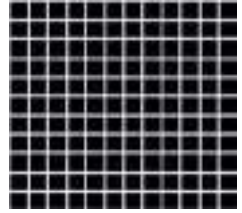

1S-AS-0790

SURFACE : GLOSSY

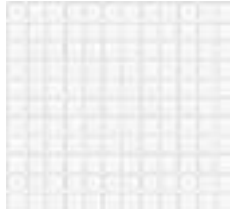

1S-6110

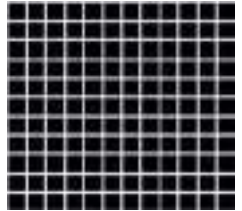

1S-6790

SURFACE : SATIN

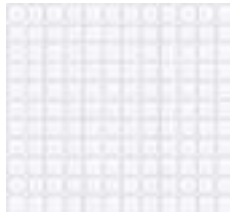

1S-MW



# 1SM

## GLAZED MOSAIC TILE

(Tile Size 23.0x23.0 mm.)  
(Sheet Size 298.0x298.0 mm.)

SURFACE : GLOSSY



1SM STRAWBERRY FIELD BLUE



1SM MARMORO WHITE

# 06S

## GLAZED MOSAIC TILE

(Tile Size 19.0x19.0 mm.)  
(Sheet Size 306.0x306.0 mm.)

SURFACE : GLOSSY

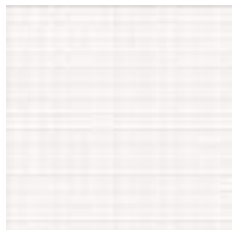

06S-6110

Glossy



06S-SPRING FLOWER

SURFACE : SATIN

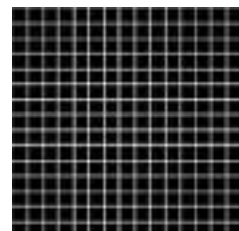

06S-6790



06S-MW

Satin

# 06T

## GLAZED MOSAIC TILE

(Tile Size 23.0x23.0 mm.)  
(Sheet Size 270.5x317.5mm.)

SURFACE : SATIN



06T-MASSA-HRB

(Tile Size 23.0x23.0 mm.)  
(Sheet Size 290x298.5 mm.)

SURFACE : SATIN



06T-MASSA-BRICK

(Tile Size 23.0x23.0 mm.)  
(Sheet Size 298.0x298.0 mm.)

SURFACE : GLOSSY



06T-6110



DECORATIVE





# NOVO CRAFT Series

is the result of our constant commitment towards the development of production technique and creativity of design. Every single chip of our mosaic is an impeccable combination of world-class quality and aesthetic touch, made to serve all kinds of architectural requirement. A wide variety of shapes, colors and finishes of mosaic are what COTTO dedicates to offer for your MASTERPIECE of space decoration.

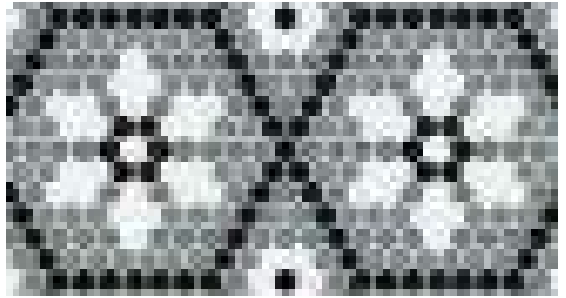

## GLAZED MOSAIC TILE

(Tile Size 23.1x26.0 mm.)

(Sheet Size 258.7x302.5 mm.)

Hexa (Sheet Size 266.1x310.2 mm.)

Chain (Sheet Size 266.1x231.9 mm.)

SURFACE : MIXED

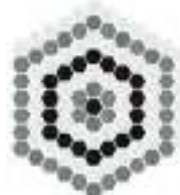

1HE NOVO HEXA WHEEL GY01

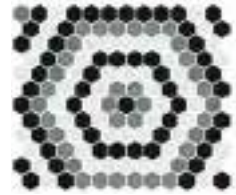

1HE NOVO WHEEL GY01



1HE NOVO HEXA MAZE GY01



1HE NOVO SNOWFLAKE GY01

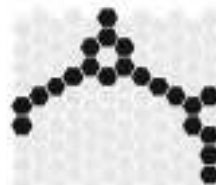

1HE NOVO CHAIN-A WH01



1HE NOVO CHAIN-B WH01





# 1HE

## GLAZED MOSAIC TILE

(Tile Size 23.1x26.0 mm.)  
(Sheet Size 258.7x302.5 mm.)

SURFACE : GLOSSY



1HE-6110

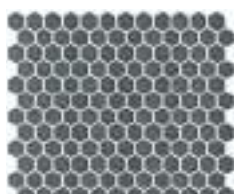

1HE-5772

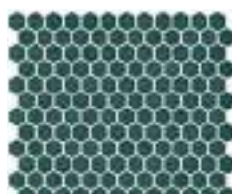

1HE-5434



1HE-5437



1HE-6471



1HE-BL-10/R



1HE-5531



1HE-5532



1HE-SILVER



1HE-COPPER

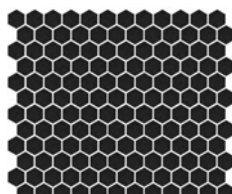

1HE-6790



1HE-MW/0790 DOT

SURFACE : SATIN



1HE-MW

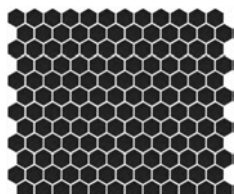

1HE-0790

SURFACE : ANTI-SLIP



1HE-AS-0111

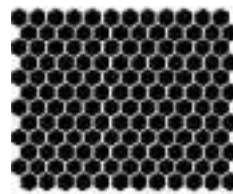

1HE-AS-0790



# 4OD

## GLAZED MOSAIC TILE

(Tile Size 97.0x97.0 mm.)  
(Sheet Size 300.0x300.0 mm.)

SURFACE : SATIN



4OD-MW/6110



4OD-MW/SL-790

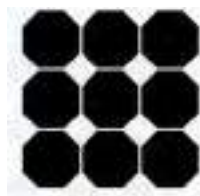

4OD-SL-790/6110

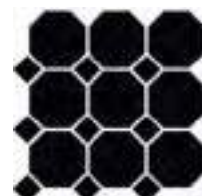

4OD-SL-790/6790

# 22HE

## GLAZED MOSAIC TILE

(Tile Size 51.1x59.0 mm.)  
(Sheet Size 277.4x320.8 mm.)

SURFACE : GLOSSY



22HE-6110

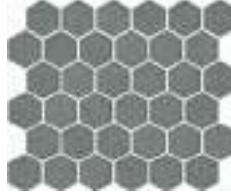

22HE-5772



22HE-5531



22HE-5532



22HE-6471



22HE-BL-10/R



22HE-5434



22HE-5437

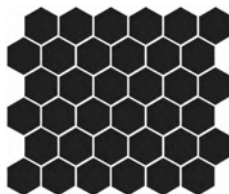

22HE-6790



22HE FLO WHITE



22HE FLO GREY

SURFACE : SATIN



22HE-MW



22HE-0790



22HE-AS-0111

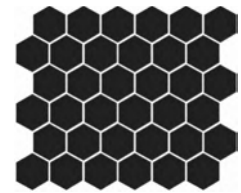

22HE-AS-0790

SURFACE : MATT



22HE GRINTA GREY

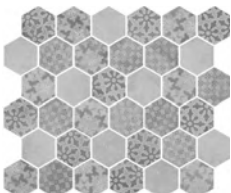

22HE CURIO GREY



22HE CURIO BLUE



# NEW SHAPE

## GLAZED MOSAIC TILE

Tile Size 74.4x70.0 mm  
 Sheet Size 309.0x267.5 mm  
 SURFACE : SATIN



ORIENTAL FAN WHITE (MATT)

Tile Size 57.0x65.0 mm  
 Sheet Size 268x260 mm  
 SURFACE : GLOSSY



LANTERN WHITE

Tile Size 48.0x86.0 mm  
 Sheet Size 278x265 mm  
 SURFACE : GLOSSY



TREE LEAF WHITE

Tile Size 48.0x70.0 mm  
 Sheet Size 290x252 mm  
 SURFACE : GLOSSY



ARABESQUE

Tile Size 60.0x240.0 mm  
 Sheet Size 252.0x364.5 mm  
 SURFACE : SATIN



WHITE MARBLE BRICK

Tile Size 48.0x48.0 mm  
 Sheet Size 309.0x267.5 mm  
 SURFACE : GLOSSY



BRICKBOX WHITE



BRICKBOX BLACK

Tile Size 22.0x145.0 mm  
 Sheet Size 300.0x296.0 mm  
 SURFACE : GLOSSY



BASIC STRIPE WHITE



BASIC STRIPE GREY

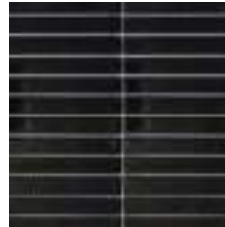

BASIC STRIPE BLACK

# ODD SIZE

## GLAZED WALL TILE

(Sheet Size 31.1x35.6 mm.)



HEX BEVEL-IN WHITE (WT)

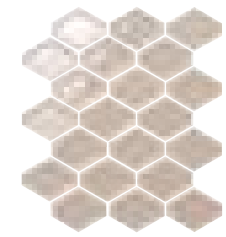

HEX BEVEL-IN GREY (WT)

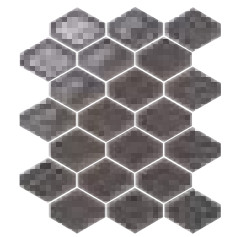

HEX BEVEL-IN BLACK (WT)

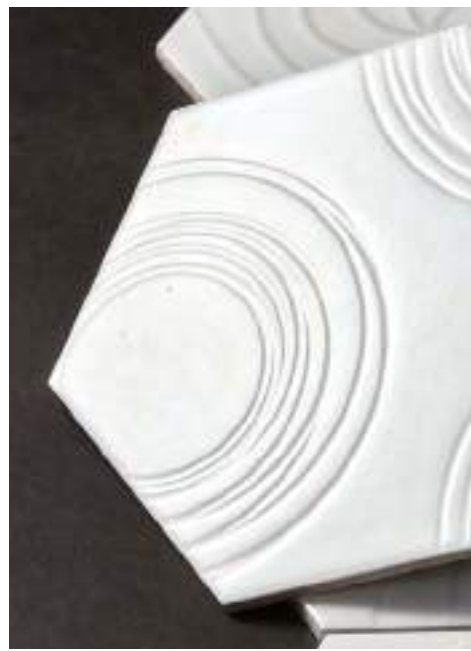

# ODD SIZE

Glazed Porcelain Tile (B1b) (Tile Size 200x230 mm.)

SURFACE : SATIN



HEX MARBLE (MATT)



HEX WHITE PLAIN

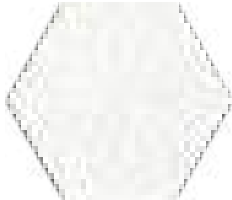

HEX WHITE DECO

## RANDOM PATTERNS



HEX GREY PLAIN



HEX GREY DECO

## RANDOM PATTERNS







# ODD SIZE

Glazed Porcelain Tile (B1b) (Tile Size 200x230 mm.)

SURFACE : SATIN



HEX BLACK PLAIN



HEX BLACK DECO

RANDOM PATTERNS



SURFACE : MATT



HEX CEMENT PLAIN (MATT)



HEX CEMENT DECO (MATT)

RANDOM PATTERNS



# GLASS MOSAIC

Sheet Size 300x300 mm.



JAZZY GOLD



JAZZY LOCO GOLD

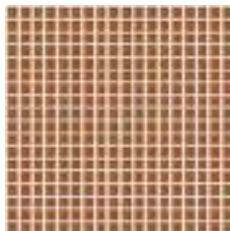

JAZZY ROSE GOLD



JAZZY LOCO ROSE GOLD

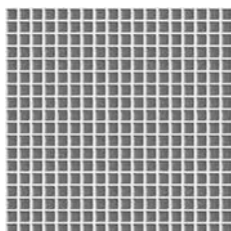

JAZZY SILVER

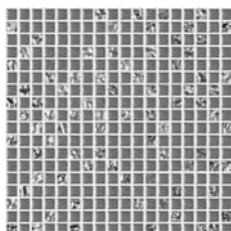

JAZZY LOCO SILVER

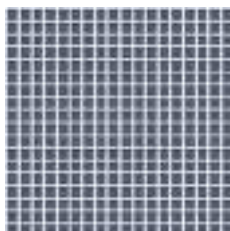

JAZZY GRAPHITE

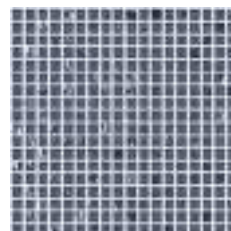

JAZZY LOCO GRAPHITE



MOLA SEQUIN CREAM



MOLA BONE



MOLA SEQUIN BROWN



MOLA GREY



CITRINE BROWN



CITRINE PINK

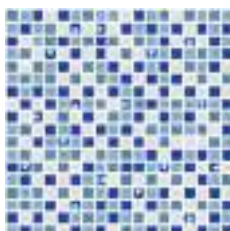

CITRINE BLUE

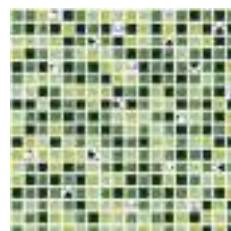

CITRINE GREEN



CITRINE GANET

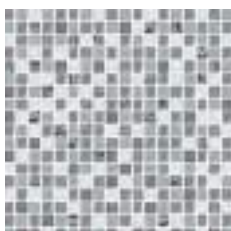

TRAFALGAR GRIGIO

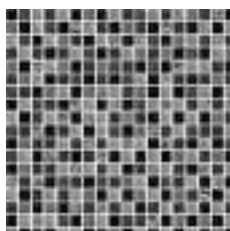

TRAFALGAR NERO

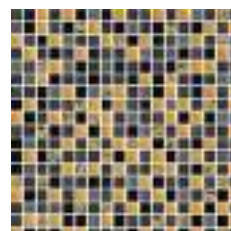

TRAFALGAR ORO

# GLASS MOSAIC

Sheet Size 300x300 mm.



GLASS BLEND(II) 02 BLACK  
(06S)



GLASS BLEND(II) 03 BLACK  
(06S)

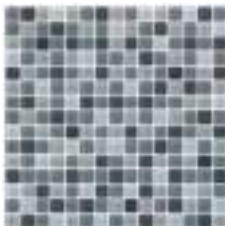

GLASS BLEND(II) 04 BLACK  
(06S)



GLASS BLEND(II) 05 BLACK  
(06S)

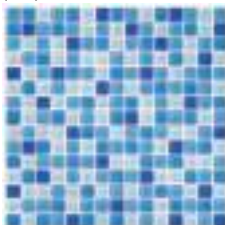

GLASS BLEND(II) 03 BLUE  
(06S)

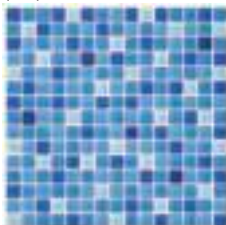

GLASS BLEND(II) 04 BLUE  
(06S)

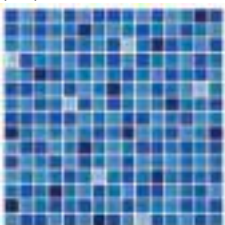

GLASS BLEND(II) 05 BLUE  
(06S)

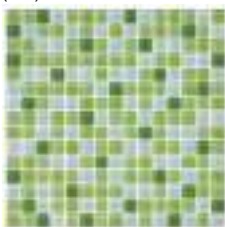

GLASS BLEND(II) 03 GREEN  
(06S)



GLASS BLEND(II) 04 GREEN  
(06S)

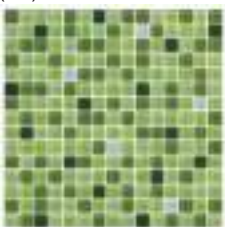

GLASS BLEND(II) 05 GREEN  
(06S)



GLASS BLEND(II) 03 PINK  
(06S)

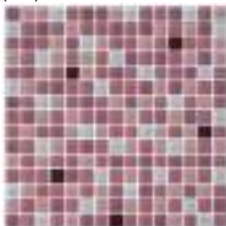

GLASS BLEND(II) 04 PINK  
(06S)



GLASS BLEND(II) 05 PINK  
(06S)

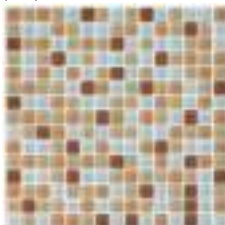

GLASS BLEND(II) 03 BROWN  
(06S)



GLASS BLEND(II) 04 BROWN  
(06S)



GLASS BLEND(II) 05 BROWN  
(06S)

# GLASS MOSAIC

Sheet Size 300x300 mm.

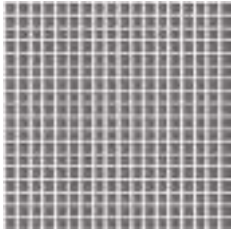

SPRAZZO SILVER

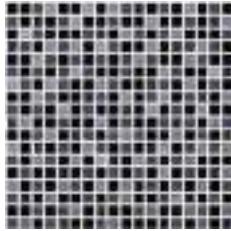

MARQUISE GLOOM

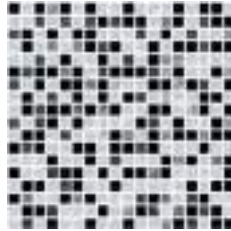

KALISI MARMO

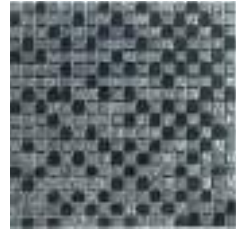

TCHALLA BLACK

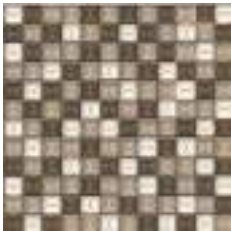

CHARLOTTE (II) BROWN (1S)

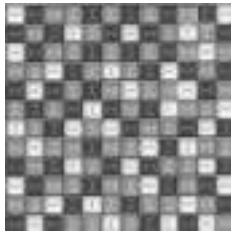

CHARLOTTE (II) GREY (1S)

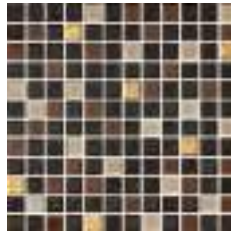

RICCA (II) BROWN (1S)

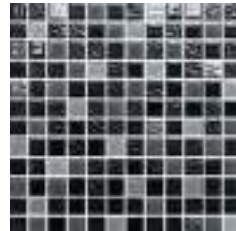

RICCA (II) BLACK (1S)

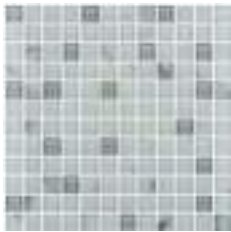

CALACATTA CLASSICO(II)  
CHIC(1S)

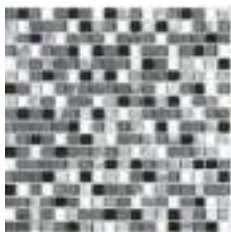

HERMIA GRIS NOIR



GLASNOST SILVER



GLASNOST GOLD

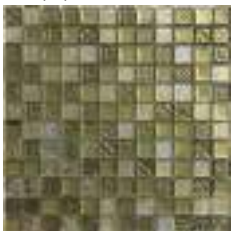

RAGNAROK GOLD



RAGNAROK SILVER

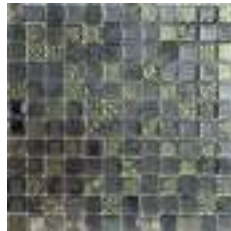

RAGNAROK BLACK



NIRVANA GOLD

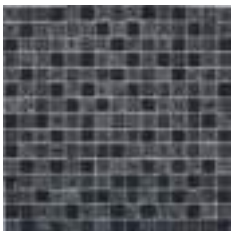

MOROCCO (II) BLACK (06S)

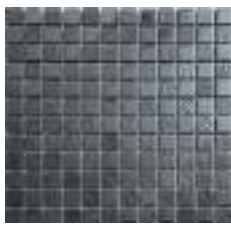

NEOLITH BLACK



OKINAWA NIGHTFALL

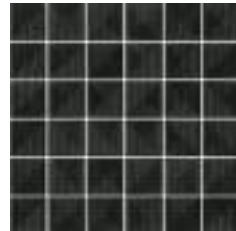

MOTION (II) FACET (2S)

# GLASS MOSAIC

Sheet Size 300x300 mm.



MCQUEEN (II) WHITE (2S)



MCQUEEN (II) BLACK (2S)

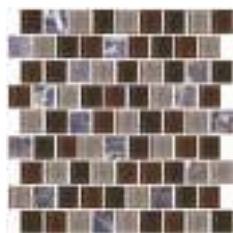

MARQUISE BAR GALET



MARQUISE BAR GLOOM

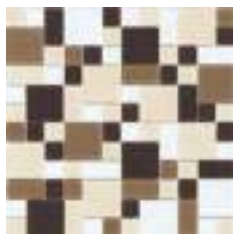

PARTY (II) BROWN



BUCKINGHAM (II) (MIX)



REBELLIO MARMO



REBELLIO TRAVERTINO



REBELLIO ZEBRANO



REBELLIO LUXORI

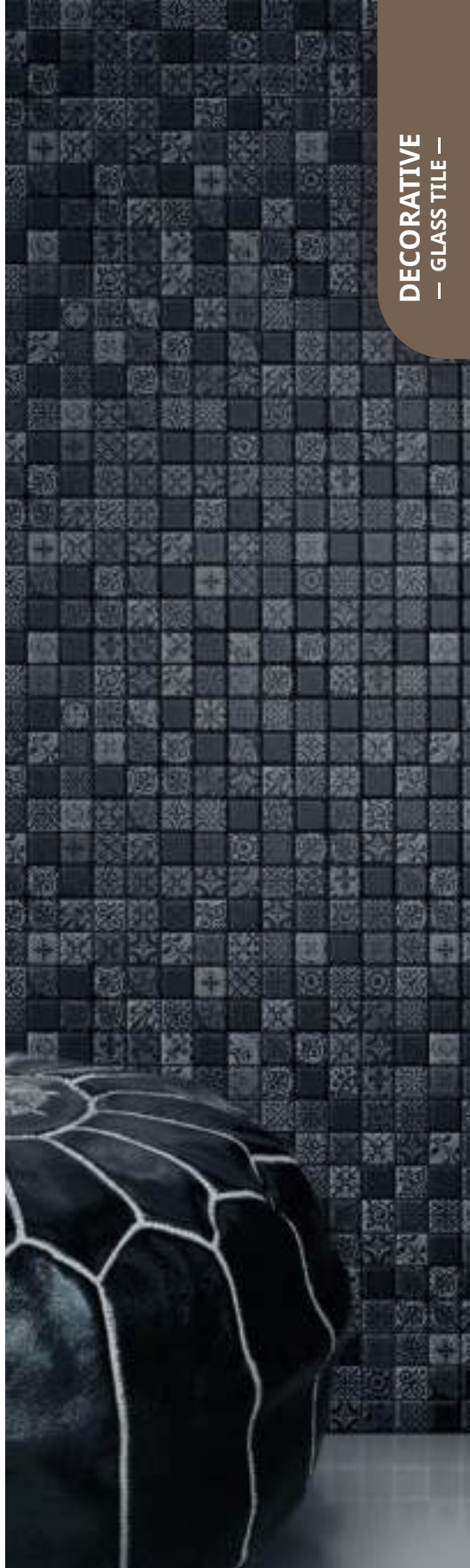

DECORATIVE  
— GLASS TILE —

# GLASS MOSAIC

Sheet Size 300x300 mm.



COLOSSI BIANCO

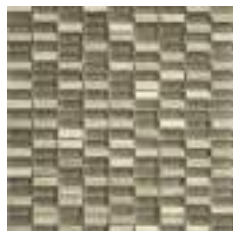

COLOSSI CHIARO



COLOSSI CREMA

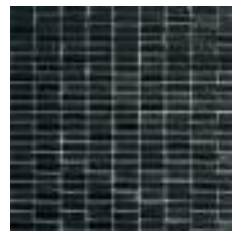

COLOSSI SCURO

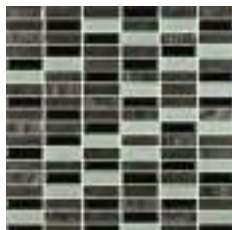

CANARY BLACK



KASHMIR (II) BLACK



GLASS BLEND(II) 03 BROWN  
(05T)



CANARY BROWN



STONEHENGE (II) GREY (05T)

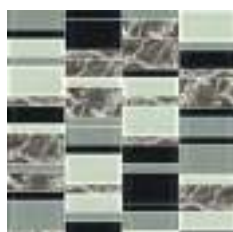

WESTMINSTER

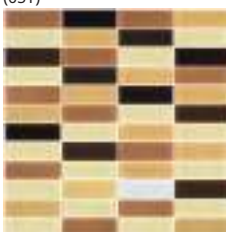

EQUALIZER(II) 02 BROWN  
(06T)

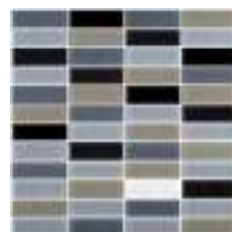

EQUALIZER(II) 02 GREY (06T)



PEDRA (II) BROWN



PEDRA (II) BLACK

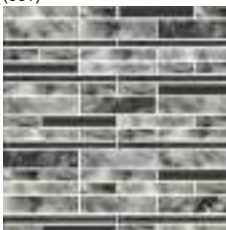

MILLENNIUM GREY



MILLENNIUM BROWN



TROY EARTHEN



TROY URBANIST



TROY EMPORIO

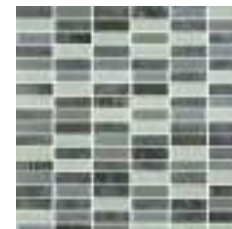

CANARY GREY



## GLASS MOSAIC

Sheet Size 300x300 mm.



ICONIC LEMON



ICONIC ORANGE



ICONIC BLUE



ICONIC BLACK

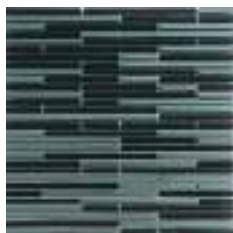

HAWKEYE BLACK

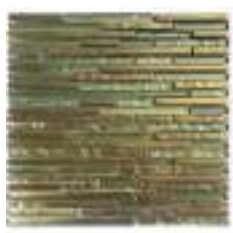

EUPHORIA LUMINOUS



INNOCENTIA PLATINUM



INNOCENTIA SILVER



CLEMENTINE SILVER



CLEMENTINE NICKLE



CLEMENTINE BRONZE







**EXTERNAL  
WALL  
& *LANDSCAPE***



**COTTO**  
**HYGIENIC**  
**TILE**  
 กระเบื้อง  
 ยับยั้งแบคทีเรีย

# STONEXT

พัฒนาและดัดแปลงมาจากลวดลายหินแกรนิตธรรมชาติที่มีความสวยงาม เหมือนจริง อีกทั้งยังเป็นสินค้าประเภท Homogeneous Tile สีเนื้อเดียวกันทั้งแผ่น แม้ว่าเกิดการสึกหรือจากการใช้งานไปเวลานาน ก็ยังคงความสวยงาม และสีของกระเบื้องอยู่มีความแข็งแรงแทนทาน เหมาะแก่การใช้ในพื้นที่ภายนอกได้เป็นอย่างดี

## UNGLAZED PORCELAIN

SIZE 9.7 x9.7 cm - THICKNESS 6 mm



4SR1-GI STONEXT BEIGE



4SR1-GI STONEXT LT GY



4SR1-GI STONEXT DK GY



### Silver Nano

ความลับในการยับยั้งเชื้อโรค  
 สู่นวัตกรรมกระเบื้องยับยั้งแบคทีเรีย

## PATTERN DESIGN



44% 47% 9%

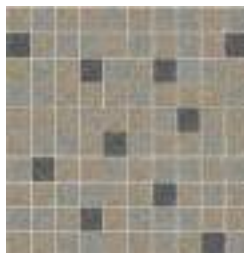

44% 47% 9%



40% 40% 20%



68% 26% 8%



## RAGTIME

### UNGLAZED PORCELAIN

SIZE 9.2 x9.2 cm - THICKNESS 18 mm



RAGTIME BONE

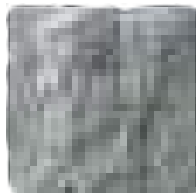

RAGTIME GREY



RAGTIME BROWN

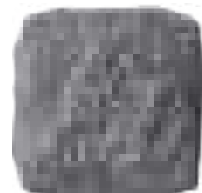

RAGTIME BLACK

## PROMSILA

### UNGLAZED PORCELAIN

SIZE 10x20 cm - THICKNESS 7.4 mm



GI-1600 PROMSILA NUESAI



GI-1700 PROMSILA TAOPIRAP



GI-7700 PROMSILA MANEENIL

# AG

## UNGLAZED PORCELAIN

SIZE 9.2 x9.2 cm - THICKNESS 13 mm

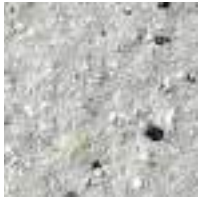

AG-01 LIGHT GREY (13mm)



AG-07 DARK GREY (13mm)



AG-33 BLACK (13mm)

SIZE 19.2X9.2 cm



AG-01 LIGHT GREY (13mm)



AG-07 DARK GREY (13mm)



AG-33 BLACK (13mm)

SIZE 19.2X9.2 cm



AG-01 LIGHT GREY (13mm)



AG-07 DARK GREY (13mm)



AG-33 BLACK (13mm)

## MODULAR USAGE

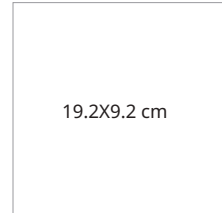

19.2X9.2 cm

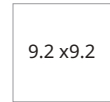

9.2 x9.2

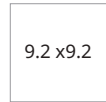

9.2 x9.2



19.2X9.2 cm

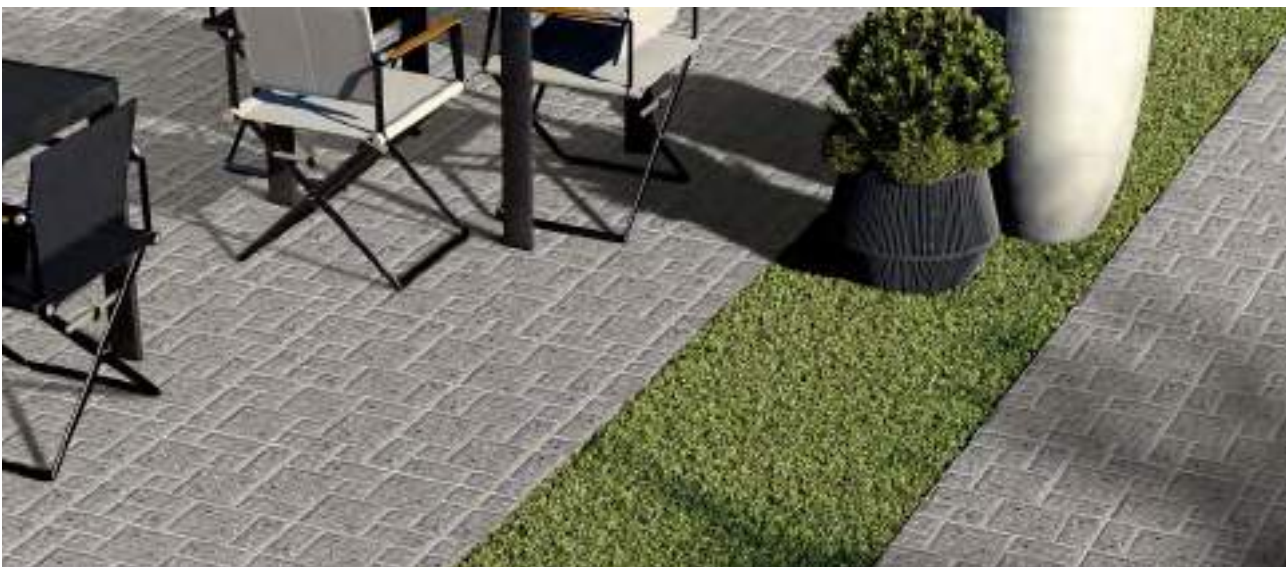

## PACKING SPECIFICATION : MOSAIC TILE

STANDARD PALLET 40"x48" (1026x1219 mm)

Tile Size	Tile Thickness	Tile Weight	Tile Area	Pallet Length (1026 mm)				Pallet Width (1219 mm)				Pallet Area	
				Rows	Cols	Total Tiles	Weight (kg)	Rows	Cols	Total Tiles	Weight (kg)	Area (sqm)	Area (sqm)
100x100	10	1.0	0.10	10	10	100	100	10	10	100	100	12.19	12.19
150x150	10	2.25	0.225	7	7	49	49	7	7	49	49	12.19	12.19
200x200	10	4.0	0.40	5	5	25	25	5	5	25	25	12.19	12.19
250x250	10	6.25	0.625	4	4	16	16	4	4	16	16	12.19	12.19
300x300	10	9.0	0.90	3	3	9	9	3	3	9	9	12.19	12.19
350x350	10	12.25	1.225	3	3	9	9	3	3	9	9	12.19	12.19
400x400	10	16.0	1.60	2	2	4	4	2	2	4	4	12.19	12.19
450x450	10	20.25	2.025	2	2	4	4	2	2	4	4	12.19	12.19
500x500	10	25.0	2.50	2	2	4	4	2	2	4	4	12.19	12.19

## TECHNICAL SPECIFICATIONS : MOSAIC TILE

Characteristics	Standards	ICC Specifications		
		CLASSIC	PROLUXO	HYPERCLASSIC
Product classification	ISO 10545-1 (EN 14411)	Group IIIa	Group IIIa	Group IIIa
Water absorption	ISO 10545-4	≤ 0.5%	≤ 0.5%	≤ 0.5%
Resistance to water	ISO 10545-4	≥ 100 hours	≥ 100 hours	≥ 100 hours
Staining strength: Hydrogen peroxide (H <sub>2</sub> O <sub>2</sub> )	ISO 10545-6	≤ 10000	≤ 10000	≤ 10000
Staining strength: Hydrochloric acid (HCl)	ISO 10545-6	≤ 10000	≤ 10000	≤ 10000
Chemical resistance: Inorganic acids and alkalis	ISO 10545-7	Minimum class IIIa	Minimum class II	Minimum class IIIa
Chemical resistance: Household and swimming pool salts	ISO 10545-7	Minimum class III	Minimum class III	Minimum class III
Staining resistance	ISO 10545-8	Minimum class I	-	Minimum class I
Dimension and surface quality				
Length and width	ISO 10545-2	± 0.2%	± 0.2%	± 0.2%
Thickness		± 0.2%	± 0.2%	± 0.2%
Irregularities of edges		± 0.2%	± 0.2%	± 0.2%
Rectification		± 0.2%	± 0.2%	± 0.2%
Grouting resistance		± 0.2%	± 0.2%	± 0.2%
Edge fracture		± 0.2%	± 0.2%	± 0.2%
Chipping		± 0.2%	± 0.2%	± 0.2%
Abrasion resistance of surface (polished tile)	ISO 10545-7	Minimum class I	-	Minimum class I
Abrasion resistance of back (unpolished tile)	ISO 10545-7	-	Minimum IIIa wet	-
Cracking resistance	ISO 10545-9	Resistant	-	Resistant
Flexural resistance	ISO 10545-10	Resistant	Resistant	Resistant

## TILE GROUT



### กาวยาแนว คอตโต้ นกกรด 3 เท่า สำหรับ ร่องขนาด 2-10 มม.

- กนกรดของน้ำยาล้างห้องน้ำ มากกว่าซีเมนต์ถึง 3 เท่า
- เหมาะสำหรับพื้นที่ห้องน้ำ ห้องครัว
- พลิตจาก อีลตรา ฟลาสเตอร์ ช่วยป้องกันราดำ และการฟุกร่อนของยาแนว



### กาวยาแนว คอตโต้ นาโนพลาสติก สำหรับ ห้องน้ำ

- ป้องกันที่ดันทะลุของราดำ
- กนทานกรด และน้ำยาทำความสะอาดห้องน้ำ



### กาวยาแนว คอตโต้ สลิมพลัส สำหรับ ร่องขนาด 0.2-2 มม.

- โหลตัวดีเอ็นเอร่องกระเบื้อง, หินธรรมชาติ 0.2-2 มม.
- เหมาะกับกระเบื้องแผ่นใหญ่ พื้นที่ห้องโถง ห้องนั่งเล่น
- พลิตจาก อีลตรา ฟลาสเตอร์ ช่วยป้องกันราดำ และการฟุกร่อนของยาแนว



### กาวยาแนว คอตโต้ นาโนพลาสติก สำหรับ สระว่ายน้ำ

- กนทานสารคลอรีน หรือเกลือที่ใช้ในสระว่ายน้ำ
- เนื้อกาวแน่น แข็งแรงสูง กนทานแรงดันของน้ำ ไม่แตกร้าว ใช้กับร่องยาแนวขนาด 2-15 มม.
- แร่งยึดเกาะสูง สดป็นอาหารหลุดล่อน ได้ดีกว่ายาแนวชนิดทั่วไป
- สามารถใช้งานในพื้นที่ภายนอก ที่มีอุณหภูมิสูง
- ป้องกันที่ดันทะลุของราดำ
- บลอดภัยต่อสุขภาพ



### กาวยาแนว คอตโต้ อีพ็อกซี่ สำหรับ สระว่ายน้ำและพื้นที่ ต้องการความทนทานสูง

- ใช้ได้กับกระเบื้องทุกชนิด
- เนื้อเนียนละเอียด ไม่เป็นเม็ดทราย
- กนกรดและสารเคมีความเข้มข้นสูง
- เป็นได้ทั้งกาวยาแนวและกาวซีเมนต์
- ป้องกันการเกิดราดำและแบคทีเรีย

## TILE ADHESIVE



### กาวซีเมนต์ คอตโต้ สำหรับ กระเบื้องดูดซึมน้ำต่ำ

- กระเบื้องเคลือบพอร์ซเลน, แกรนิตได้ปูพื้นขนาดไม่เกิน 24"x24"
- เหมาะสำหรับงานปูพื้นและผนังห้องน้ำ ห้องครัว ห้องนั่งเล่น
  - เนื้อกาวดูดซึมน้ำต่ำ ป้องกันปัญหาความชื้นซึมผ่านเนื้อกาว



### กาวซีเมนต์ คอตโต้ฟลิกซ์ สำหรับ ปูกับกระเบื้องเดิม

- ปูกับกระเบื้องเดิมและพื้นที่สันเสมอกัน
- ใช้ได้กับกระเบื้องเรขาคณิตทุกชนิดทุกประเภท ทุกขนาด
- ใช้กับพื้นผิวไม่ขัดกรองสร้างและสามารถถอด
- พลิตจาก อีลตรา ฟลาสเตอร์ เนื้อเนียนละเอียด ช่วยเพิ่มพื้นที่การยึดเกาะ ไม่หลุดล่อน



### กาวซีเมนต์ คอตโต้ สำหรับ กระเบื้องทั่วไปภายใน

- เหมาะสำหรับปูพื้นและผนังทั่วไปภายใน
- พลมชาย ฉนวน เมาแรง
- พลิตจาก อีลตรา ฟลาสเตอร์ เนื้อเนียนละเอียด ช่วยเพิ่มพื้นที่การยึดเกาะ ไม่หลุดล่อน



### กาวซีเมนต์ คอตโต้ สำหรับ กระเบื้องแผ่นใหญ่ 24"x24" ขึ้นไป

- เหมาะสำหรับปูกระเบื้องแผ่นใหญ่ กระเบื้องแกรนิตโต้
- ใช้ได้ทั้งภายในและภายนอก
- สามารถใช้ติดตั้งกระเบื้องกับสระว่ายน้ำ



### กาวปูกระเบื้อง คอตโต้ นาโนพลาสติก สำหรับ ห้องน้ำ

- ยึดติดแน่นสนิท ป้องกันปัญหา กระเบื้องหลุดล่อน
- เนื้อแน่น ไม่ยุบตัวหลังแห้งสนิท



### กาวปูกระเบื้อง คอตโต้ นาโนพลาสติก สำหรับ สระว่ายน้ำ

- ยึดเกาะแน่น สดป็นอาหาร กระเบื้องหลุดล่อนในสระน้ำ ด้วยสารลาทิกซ์พอลิเมอร์และเคมีภัณฑ์ชนิดพิเศษ พลังงานโมเลกุลขนาดเล็กลงของนาโนพลาสติกช่วยเพิ่มแรงยึดเกาะและยึดหยุ่นตัวได้ดีต่างจากปูนซีเมนต์ทั่วไป

# บริการรับติดตั้ง กระเบื้องเซรามิกและโชนิล



**ตรง  
เวลา**

**มั่นใจ**  
ในคุณภาพ

**จบ**  
ไม่บานปลาย

**รับประกัน**  
**1ปี**



## ติดต่อประสานงาน

วีรนิชณ์	081-3787288	veeranis@scg.com
อดิศร	081-9315186	adisorku@scg.com
อเมศ	092-2762159	ammartpo@scg.com





2<sup>nd</sup> floor, SCG Experience  
Tel: 02 101 9922

[www.cottolife.com](http://www.cottolife.com)

 @COTTOLife

บริษัท เอสซีซี เซรามิกส์ จำกัด (มหาชน)  
1 ถนนสุขุมวิทไทย บางซื่อ กรุงเทพฯ 10800

SCG Ceramics Public Company Limited  
1 Siam Cement Rd., Bangsue, Bangkok 10800



Certified Management System  
ISO 9001:2000  
ISO 14001:2004



- \* โปรดศึกษา "คู่มือการใช้สินค้า" และ "คู่มือการติดตั้ง" ให้เข้าใจก่อนการใช้งานจริง
- \* สีในรูปตัวอย่างอาจแตกต่างจากจริงเนื่องจากสีที่เปลี่ยนเนื่องจากการพิมพ์
- \* รายละเอียดต่างๆ ที่ระบุในเอกสารนี้ บริษัทฯ อาจเปลี่ยนแปลงได้ตามความเหมาะสม โดยไม่ต้องบอกกล่าว
- \* *Color of tiles in this print may vary slightly due to the printing process.  
Final color selection should be made from tile samples.*
- \* *The detail information in this print may be modified or updated  
by the company without prior notice.*

